

Uniden®

UH825 Series **Handheld UHF-CB Transceiver**

OWNER'S MANUAL

Warning



NOTE

IMPORTANT INFORMATION

Uniden does not represent the UH825 radio to be waterproof. Do not expose the UH825 to rain or moisture.

LITHIUM ION BATTERY PACK WARNING

- This equipment contains a Lithium Ion Battery Pack.
- The Lithium Ion Battery Pack contained in this equipment may explode if disposed of in a fire.
- Do not short-circuit the Battery Pack.
- Do not charge the Lithium Ion Battery Pack used in this equipment in any charger other than the one designed to charge this Battery Pack. Using another charger may damage the Battery Pack or cause the Battery Pack to explode.
- Lithium Ion batteries must be disposed of properly.



NOTE

USER LICENSE INFORMATION

The citizen band radio service is licenced in Australia by ACMA Radio-communications (Citizen Band Radio Stations) Class Licence and in New Zealand by MBIE General User Licence for Citizen Band Radio and operation is subject to conditions contained in those licenses.

Contents

Introduction	
Features	4
Included in your Package	5
Optional Accessories	5
Controls and Indicators	6
Getting Started	
Attaching the Antenna & Beltclip	7
Attaching the Battery Pack	8
Charging the Radio Dual Drop-in Charger (UH825 Only)	9
Charging the Radio Single Radio Charging	9
Battery Level Display & Automatic Battery Save	10
Accessory Jack (SPKR/MIC) Cover	10
Connecting the Optional SPKR/MIC	10
Operation	
Menu	
Power On/Off	11
Volume	11
Selecting a Channel	12
How to Transmit and Receive High/Low Transmit Power	13
Squelch	14
Call Function	15
Using a Repeater Channel	15
To Operate UH825 in Duplex Mode	16
Scanning	17
What is Open Scan (OS) Mode?	17
What is Group Scan (GS) Mode?	17
Selecting OS or GS Scan Mode	18
Add/Remove Channels from SCAN Memory	18
To Start Channel SCAN	18
Master Scan	20
Menu Functions	22
CTCSS / DCS	22
Priority Watch/Priority Channel	23
VOX (Built-in Voice Activated Circuit)	23
BCL (Busy Channel Lockout)	24
Call Tone (Selecting a Call Tone)	24
Roger Beep/Key Beep	25
Backlight (Timer)	25
Smart Key	25
Key Lock	26
Factory Reset	26
CTCSS & DCS Codes and Frequencies	27-29
UHF-CB Channel Guidelines, Channels & Frequencies	29-31
Warranty	32-33

Introduction

The UH825 is a 2W, portable two-way UHF-CB radio. This hand held UHF-CB radio is designed to give consistent, outstanding performance in many conditions and situations. To ensure that you get the most from the UH825 features, please read this operating guide carefully before using the unit.

FEATURES

- 80 Channel UHF-CB Radio¹
- 2W Max TX Power
- 2W/0.5W Switchable TX Power
- LCD Dot Matrix Display
- Backlit Display and Keypad
- USB-C charging²
- 38 Built-in CTCSS and 104 DCS codes
- Duplex Mode for Repeater Access¹
- 5 Call Tones
- Open Scan with programmable CH memory
- Group Scan with Priority CH Watch
- Master Scan
- Programmable SMART Key (Call, NFC or Pri CH)
- Busy Channel Lockout Function
- VOX Function
- Key Beep
- Roger Beep
- Keypad Lock
- Backlight On/Off/Timer
- Accessory Jack for Earpiece Mic or Speaker Mic
- Rechargeable Lithium-Ion Battery
- Low Battery Alert
- Battery strength Indicator
- Auto Battery Save

¹ Refer to page 27 - page 29 for channel information

² Requires optional USB-C cable for direct battery/radio charging.

Included in your Package

Items	UH825	UH825-2TP
UH825 UHF Radio	1	2
Lithium Battery (2000mAh)	1	2
Antenna	1	2
Beltclip	1	2
USB-C Charge Cable	1	1
Dual Drop-In Charge Cradle	-	1
AC Adaptor for Charging	-	1
DC Cig-Lead Adaptor for Charging	-	1
Speaker Mic	-	2
Earpiece Mic	-	2
Hard Carry Case	-	1
Owner's Manual	1	1



If any of these items are missing from the box, contact your place of purchase, immediately.

Optional Accessories

- Speaker Mic
- Earpiece Mic

Visit the UH825 page on the website for more information on the availability & range of optional accessories; www.uniden.com.au

Controls and Indicators

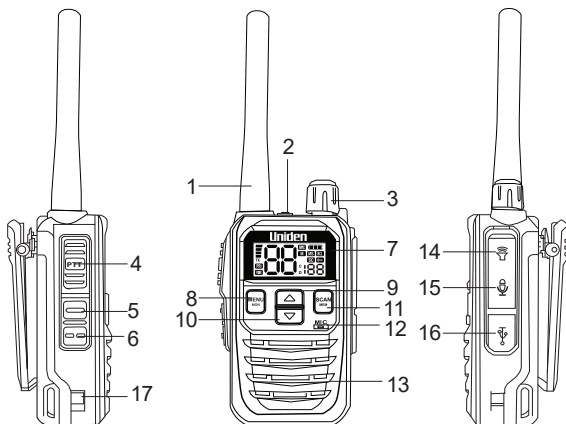

- 1 50Ω Antenna
- 2 Indicator light
(Red - Transmit/charging)
(Green - Receive/fully charged)
- 3 Rotary Vol/Power Knob
- 4 PTT(Push to Talk) KEY
- 5 Return/Lock Keypad Key
- 6 SMART Key
- 7 LCD Display
- 8 MENU/MONITOR Key
- 9 UP Keys
- 10 DOWN Key
- 11 SCAN/MEM Key
- 12 Microphone
- 13 Speaker
- 14 Accy Earphone/Speaker MIC Jack
- 15 Accy Speaker MIC Jack
- 16 Type-C Charging Port
- 17 Drop-in Charger Pin

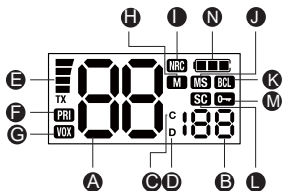

- A Current Channel
- B **CTCSS / DCS** and code number
- C **CTCSS** Display
- D **DCS** Display
- E **HI / LO** TX Power
- F Priority Watch
- G **VOX** Voice Activation On
- H **SCAN CH** Memory
- I NRC
- J Master Scan
- K Busy Channel Lockout
- L Scan for All Channels
- M Key Lock
- N Battery Indicator

Getting Started

Attaching the Antenna

Attaching the Beltclip

The belt clip attaches to the battery pack and may be pre-installed for convenience on some model packages.

To attach the belt clip:

1. Slide the belt clip into the catch at the top of the battery until it snaps into place.

To remove the belt clip:

1. Pinch and hold the belt clip latch and then slide the belt clip up and out of the catch. (Belt clip can be removed from the battery cover even when installed in the radio.)

Getting Started

Attaching the Battery Pack

1. Install the battery pack into the back of the radio making sure the tabs at the top of the battery slide in first.
2. Push battery all the way up until it the battery latch at the bottom locks into place. Be sure the battery pack fits tightly against the UH825 body.



Avoid exposing the Lithium Ion battery, attached or unattached to the radio, in direct sunshine, heated cars, or in areas with temperatures below -20°C (-4°F) or above $+60^{\circ}\text{C}$ ($+140^{\circ}\text{F}$).

Exposing the chemicals contained within the battery pack to temperatures above $+60^{\circ}\text{C}$ ($+140^{\circ}\text{F}$) may cause the battery to rupture, fail or reduce performance.

In case of exposure to cell contents, wash the affected area thoroughly, and seek medical attention.

Additional battery cautions should be applied as described on page 2.

Getting Started

Charging the Radio | Dual Drop-in Charger (UH825-2TP Only)

Plug the AC adapter into a wall outlet and connect the USB-C charge cable to the AC adaptor and the drop-in charger.

If you use the drop-in charger in a mobile vehicle with 12V DC power, use the optional cig-lead adaptor.

When the charger is powered, the LED illuminates red.

When fully charged, the LED illuminates green.

Your radio is powered by a specially designed Lithium Ion battery pack.



NOTE

For the initial battery charge, make sure the radio is off for optimum charging.

1. Place the UH825 in the drop-in charger.
 2. If the radio battery is charging, the LED illuminates red and stays on, until fully charged, then it illuminates green.
- The charger won't overcharge the battery pack. When charging is completed, the charge LED changes colour from red to green.
 - You can monitor incoming calls while the UH825 is in the drop-in charger however, optimum charging happens when the radio is off.
 - **Do not transmit when the UH825 is in the drop-in charger!**

Charging the Radio | Single Radio Charging

A single UH825 Radio can be charged directly with the USB-C cable connected to a standard 5V USB charging port.

Getting Started

Battery Level Display

LEVEL 4 Battery 100% full



LEVEL 3 Battery approx. 75% capacity



LEVEL 2 Battery approx. 25% capacity



LEVEL 1 Battery exhausted



Recharge the battery at any time. From empty, the battery will take up to 5 hours to fully charge.

Battery Life : 23 Hours (Typical)

This is based on the following Duty Cycle:

Transmit (Low Power)	5%
Receive	5%
Stand-by	90%

Automatic Battery Save

The Automatic Battery Save feature extends the battery life by switching to power save mode if it remains out of operation for 10 seconds. This feature automatically activates during standby mode (RX mode without a signal).

Accessory Jack Cover

Make sure the SPKR/MIC jack cover is firmly pushed in to minimise dust and moisture entering the radio.

Connecting the Earpiece Mic or Optional Speaker Mic

Release the accessory jack cover to plug in the accessory.

Operation

- See the Controls and Indicators on page 6 of this operating guide for control knob and key operations.
- In addition to the key and control knob functions, many features are available in the Menu.

MENU

01	Transmit Power Level	09	Duplex Mode (Rep.)
02	Squelch	10	NRC Level
03	CTCSS / DCS	11	VOX Setting
04	Priority Watch	12	BCL
05	Priority Channel (if 04 is ON)	13	Call Tone
06	Scan Mode	14	Roger Beep
07	Master Scan	15	Backlight
08	Master Code	16	Key Beep
		17	Battery Save

- For MENU function operation, see page 20.

Power On/Off

To turn the unit **ON**, rotate the **[ON/OFF VOL]** clockwise. A channel number and battery level should appear on the display.

To turn the unit **OFF**, rotate the **[ON/OFF VOL]** knob counter-clockwise. The display will disappear.

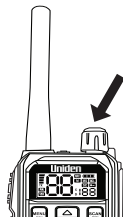

Volume

Rotate the **[ON/OFF VOL]** knob clockwise or counter-clockwise to adjust speaker volume to a desired listening level.

Getting Started

Selecting a Channel

Press [▲] or [▼] to select the desired channel.

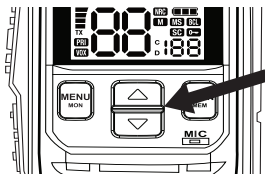

NOTE

For your reference a list of the available channels, corresponding frequencies and guidelines for their use and selection is printed on page 27. For Australia, Channels 05 and 35 are reserved for Emergency Calls.

Operation

To Transmit and Receive

The UH825 uses the UHF-CB Channels. For your reference a list of the available channels and corresponding frequencies is printed on page 28 - page 29.

The maximum RF transmit power of the UH825 is 2 Watts.

To switch between 2 Watts (Hi) and 0.5 Watt (Lo) power:

1. Press **[MENU/MON]**.
LO or **HI** appears on the LCD display.

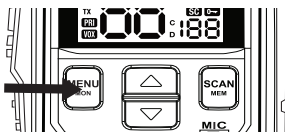

To Transmit and Receive:

1. Before you transmit, listen for activity on the selected channel.
2. When the channel is clear, press and hold the **[PTT]** to transmit.
The indicator light on red, and the "TX" appears on screen.

Hold the radio with microphone approximately five cms in front of your mouth with the antenna at approximately 45° angle away from your head. Speak in a clear, normal conversational voice.

3. When you have finished speaking, release the **[PTT]** and wait for a response. The indicator light LED turns off and the "TX" sign disappears from the LCD.

The indicator light lights up red/green, and the "RX" sign appears on the LCD when a transmission is being received by your radio.

Operation

Squelch

The squelch is used to eliminate the annoying background noise when there is no signal present on a channel. The squelch circuit does this by controlling when the radio's speaker turns on, based on the strength of received signals.



NOTE

Make sure to first select a channel not in use before setting the squelch in your UH825 UHF-CB radio.

The Auto Squelch feature has 0-5 preset squelch levels:

- 0 - max sensitivity (min squelch): Speaker is ON.
- 2 - med sensitivity (med squelch): Default setting.
- 5 - min sensitivity (max/tight squelch): Less interference. It requires no adjustment.

To set the Squelch level:

1. Press **[MENU/MON]** 2 times to enter the squelch setting list.
2. Press **[▲]** or **[▼]** to select the desired squelch level 0-5.
3. Press & hold **[SCAN/MEM]** to save the setting.

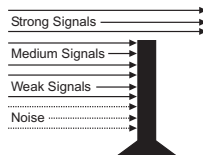

NOTE

If an incoming signal is very weak there is a possibility that you will have a choppy or broken reception, due to the sensitivity of the squelch. In this case, adjust the squelch level accordingly.

Operation

Call Function

The Call function transmits a short “wake up” tone to notify other users of impending communication. You may select from 5 types of tones (see *Call Tone (Selecting a Call Tone)* on page 22).

To use the Call function:

1. Before you use Call, make sure the channel is not in use.
2. Long press [↔] Smart Key until [Ca] appears, then press to make Call and the Call Tone will be transmitted.



NOTE

Current regulations require calling tones to be restricted to one transmission per minute. If a second transmission is attempted within one minute then an error tone will sound.

Using a Repeater Channel

UHF-CB Repeaters are used to retransmit or relay your signal. Repeaters will extend the range of your radio and overcome the shielding effect caused by solid obstructions.

In normal Simplex operation, your radio transmits on one particular frequency and receives on that same frequency. If there is a barrier (i.e. a Tall Building) that partially blocks your transmitted signal, the possibility of the other radio receiving the signal is very slim. Valleys, metallic structures, etc., tend to act as a screen between radios.

Standard Operation without the aid of a Repeater Station



Operation with the aid of a Repeater

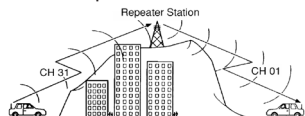

Operation

With Duplex operation, the signal coming from your radio is received by the Repeater station and then re-transmitted at the same time on another channel.

For example:

1. CH01 is on Duplex Mode - will receive on CH01 but Transmit on CH31
2. CH41 is on Duplex Mode - will receive on CH41 but Transmit on CH71, etc... Refer to UHF-CB Channel & Frequencies table on p.28 - p.29.

If you transmit on CH01 Duplex mode, you are actually transmitting on CH31, and the repeater station down-converts your signal and retransmits on CH01.

To Operate in Duplex Mode (using a Repeater)

Only channels 01 - 08 and 41 - 48 are available for Duplex.

1. Press **[MENU/MON]** 8 times.
2. Scroll down the list to **DUPLEX MODE**.
3. Select channel 01 - 08 in duplex mode, display as **R1 - R8**.
4. Select channel 41- 48 in duplex mode, display as **N1 - N8**
5. Save the setting by pressing and holding **[SCAN/MEM]**.

Icon appears on the channel when Duplex setting is enabled for a duplex capable channel.

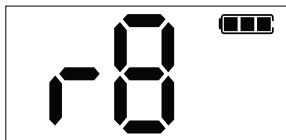

NOTE

Search online for available UHF-CB repeaters in your area.

Operation

Scanning

The scan feature allows you to search for active channels automatically. You can only scan channels that are stored in the Scan memory.

The UH825 has eight Scan modes;

- Open Scan (OS)
- Group Scan (GS)
- Memory Scan (MS)
- Preset Scans: P1, P2, P3, P4

Indicated by the **SC** or **GS** icon on the LCD. A channel is stored in the scan memory of the current scan mode when the **[M]** icon appears beside the channel number.



NOTE

By default the UH825 is set to OS scan mode with all UHF-CB channels stored into the OS channel memory. The GS scan memory by default is stored with Ch09-20 channels but can be customized according to User's choice.

You can change or customize the channels stored in OS or GS scan memory by following the steps on *Add/Remove Channels from SCAN Memory* on page 18.

What is Open Scan (OS) Mode?

OS is the default scan mode which scans all memory (MEM) channels in the OS scan memory. If an active channel is found, scanning will pause on that channel while there is a signal.

What is Group Scan (GS) Mode?

GS allows you to monitor the default stored channels or the user defined stored channels along with Priority channel (if enabled) for scanning.

What is Master Scan (MS) Mode?

Master Scan when enabled allow continual communication across congested channels. Master Scan scans group of different set of stored channels and only opens the squelch for signals with the correct subcode (CTCSS or DCS tone).



NOTE

If GS Scanning is initiated when there are no channels programmed in GS scan memory, an error tone will be heard and scanning will not start.

Operation

Selecting OS or GS Scan Mode

1. Press **[MENU/MON]** 5 times to select **SCAN MODE**.
2. Press **[▲]** or **[▼]** to select:
 - OS:** Scan all channels (By Default mode)
 - GS:** Scan saved channels (CH09-20 - By Default)
 - MS:** Scan channels in MASTER SCAN
 - P-/P1:** MASTER SCAN uses CH09-20
 - P2:** MASTER SCAN uses CH21-30, 39, 40
 - P3:** MASTER SCAN uses CH49-60
 - P4:** MASTER SCAN uses CH61-70, 79, 80
3. Save the setting by pressing and holding **[SCAN/MEM]**.

Add/Remove Channels from SCAN memory

1. Select the Scanning mode as explained above and exit the menu by pressing PTT.
2. Press **[▲]** or **[▼]** to select the channel you want to store.
3. Press and hold **[MEM]** for 1.5 sec to store.
 - “M” icon appears near to that channel and a short tone beep is heard.
4. To remove the channels from Memory:
 - Press and hold **[MEM]** for 1.5 seconds once more.
 - A short tone beep is heard and the “M” icon disappears.

To Start Channel SCAN

1. Press **[SCAN]** and the radio will begin scanning the channels that are in the OS or GS memory - depending on which of these is currently active. **SCAN** icon flashes during scanning. Press **[PTT]** to return the original set channel.

Scan Direction

SCAN will begin scanning for active channels in a sequential order.

You can change the scan direction (increasing or decreasing channel number) by pressing **[▲]** or **[▼]**.

Operation

Drop-out delay

When SCAN finds a busy channel it pauses scan to receive the signal. When the received signal stops, the radio waits for 3 seconds for the return of the signal, otherwise, the radio resumes scanning.

Recent Active Channels

SCAN remembers recent active channels and monitors these channels for activity while scanning through the scan memory. This means if recently active channels become active again during SCAN, the radio will pause on these channels first. This makes scanning for active channels more efficient (faster) the longer SCAN is operating.

Skipping an Active Channel

When paused on an active channel it is not possible to skip this channel as the recent active channel feature will cause scan to lock back onto that active channel. Wait for the active channel to become inactive and SCAN will resume. If you want to avoid an active channel completely, deactivate SCAN and remove the channel from the scan memory, then reactivate SCAN.

Priority Channel in GS Mode

In GS mode, if the the Priority channel is enabled, the scan will also include the set Priwatch Channel along with the stored channel. Radio will automatically pause on the priority channel when it gets active. By disabling the Priority Channel, It will not included in scan. (see p.21)

2. To deactivate SCAN, press **[SCAN]** .
3. During the **MASTER SCAN**, reception is only possible if the **MASTER CODE** (CTCSS/DCS) is set with the same code on both the radio devices using the same stored communication channel.

If SCAN is deactivated while it is tuned to an active channel, the UH825 will stay on that active channel.



NOTE

If SCAN is deactivated while in-between active channels, the UH825 will reinstate the last active channel.

If SCAN is deactivated when no active channel has been found, the UH825 will reinstate the starting channel.

Operation

Master Scan

It allows continual communication across the congested channels.

Master Scan scans the channels stored into Group Scan (GS) memory and only opens the squelch for signals with the correct Master Code (CTCSS/DCS).

To achieve this, all radios in your group must have tuned the same set of channels stored in the GS memory and enabled with the same Master code.

By scanning only the selected group channels with common enabled master code, radios in the network will be able to detect and receive group transmission in continuous manner without any interruption. When transmitting in this mode, the radio auto switches to an unused group channel with no code, or the wrong code. In this way, all group users will be able to have continual communication to or from other users.

The default mode for Master Scan is set with the stored channel from CH09-Ch20 with the master code CTCSS01. The group scan memory can be changed channel by channel if desired, but for Master Scan to work effectively, each radio in the group must have the same channels in the GS memory.

Refer to P.18 to see how to add/remove channels from the Scan memory.



RX only channels (CH22, CH23, CH61, CH62 and CH63) will not be included in MASTER SCAN mode even though stored into GS memory. Also channels for which the duplex setting are ON will be skipped in MASTER SCAN mode.

Operation

To operate in Master Scan mode

1. Press [**MENU/MEM**] **5 times** to select scan mode
2. Press [**▲**] or [**▼**] to select Master Scan (MS)
3. Press and hold **MEM** to save the setting and press PTT to exit the menu.
4. “**MS**” will appear on the LCD Screen.

To change the Master Scan settings

1. Press [**MENU/MEM**] **6 times** to select Master Scan.
2. Press [**▲**] or [**▼**] to select the following groups

P-: Default Mode of Master Scan which uses the current stored Channels in GS memory.

P1: Master Scan uses CH09-20.

P2: Master Scan uses CH21-30, 39, 40.

P3: Master Scan uses CH49-60

P4: Master Scan uses CH61-70, 79, 80.

3. Press and hold **MEM** to save the setting and press PTT to exit the menu.
4. Press [**MENU/MEM**] **7 times** to select Master Code.
5. Press [**▲**] or [**▼**] to select the desired code (CTCSS/DCS)
6. Press and hold **MEM** to save the setting and press PTT to exit the menu.



NOTE

If a button is not pressed within 10 sec, the UHF CB radio will automatically exit the menu mode.

Operation | Menu Functions

Menu Functions

01	Transmit Power Level	09	Duplex Mode (Rep.)
02	Squelch	10	NRC Level
03	CTCSS / DCS	11	VOX Setting
04	Priority Watch	12	BCL
05	Priority Channel (if 04 is ON)	13	Call Tone
06	Scan Mode	14	Roger Beep
07	Master Scan	15	Backlight
08	Master Code	16	Key Beep
		17	Battery Save

To use the MENU:

1. Press **[MENU/MON]** to enter the menu or setting.
2. Press **[▲]** or **[▼]** to select the Menu item you want to view.
3. Save setting changes by pressing and holding **[SCAN/MEM]**.

The radio will exit the menu after 3 seconds if no key is pressed.

CTCSS / DCS

CTCSS (Continuous Tone Coded Squelch System)

The CTCSS squelch codes allows a group to talk to each other without hearing other users on the same channel. The group needs to use the same code. And as there are 38 CTCSS codes available the chances of nearby users using the same code is unlikely.

DCS (Digital Coded Squelch)

DCS is a digital version of CTCSS. It provides 104 extra, digitally coded squelch codes that follow after the 38 CTCSS codes. Follow the steps for changing CTCSS code but select a DCS code as desired.

To use CTCSS or DCS:

1. Press **[MENU/MON]** **3 times** to select **CTCSS/DCS**.

Operation | Menu Functions

2. Press [**▲**] or [**▼**] to select a CTCSS or DCS code.
 - There are 38 CTCSS codes available.
 - There are 104 DCS codes available
 - To turn off CTCSS / DCS, select OFF.
 3. Save the setting by pressing and holding [**SCAN/MEM**].
- CTC** or **DCS** icon, and the code number appears when a code is selected for a channel.



Channels 5 and 35 are used for emergency channels. CTCSS/DCS will not operate on these channels.

Priority Watch (PRIWATCH)

1. Press [**MENU/MON**] **4 times** to select **Priwatch**.
2. Press [**▲**] or [**▼**] to select **OFF/ON**. By default its OFF.
3. Press and hold [**SCAN/MEM**] to save the setting and exit the menu.

Setting the Priority Channel (PRI CH)

1. After turning ON Priwatch, Press [**MENU/MON**] **5 times** to select Pri CH.
4. Press [**▲**] or [**▼**] to select **CH 01-80**. By default, ch-05 is PRI CH.
5. Save the setting by pressing and holding [**SCAN/MEM**].

VOX (Built-in Voice Activated Circuit)

VOX is Voice activated transmission, no pressing of the PTT key. For optimum performance, use VOX when the accessory earpiece is connected. When VOX is turned on (levels 1-3) the earpiece microphone is most sensitive at level 1, and least sensitive at level 3.

To use VOX:

1. Press [**MENU/MON**] **10 times** to select **VOX**.
 3. Press [**▲**] or [**▼**] to select a desired VOX level.
 4. Save the setting by pressing and holding [**SCAN/MEM**].
- VOX** icon appears at the bottom left of the LCD when a VOX setting is enabled.

Operation | Menu Functions

NRC Level

NRC (Noise reduction circuit) is a noise reduction and voice enhancer function.

1. Press **[MENU/MON] 9 times** to select **NRC Level**.
2. Scroll to select from **01** - weak noise reduction to **03** - strong noise reduction using **[▲]** or **[▼]**.
3. Save the setting by pressing and holding **[SCAN/MEM]**.

BCL (Busy Channel Lock-out)

This feature prevents accidental transmission on a busy channel. This is recommended on channels where CTCSS or DCS is being used. If you hear sound from the speaker, the BCL feature will prevent you from transmitting.

To activate BCL:

1. Press **[MENU/MON] 11 times** to select **BCL**.
2. Select ON or OFF by using **[▲]** or **[▼]**.
3. Save the setting by pressing and holding **[SCAN/MEM]**.

Call Tone (Selecting a Call Tone)

Select from 5 calling tones to use with the Call Tone function.

To change the Call Tone pattern:

1. Press **[MENU/MON] 12 times** to select **CALL**.
2. Then, press **[▲]** or **[▼]** to select a desired Call Tone pattern.
As you change selections the tone pattern will sound.
3. Save the setting by pressing and holding **[SCAN/MEM]**.

Operation | Menu Functions

Roger Beep

Roger Beep automatically adds a sign-off tone to the end of transmissions.

1. Press **[MENU/MON]** **13 times** to select **Roger Beep**.
2. Scroll to select ON or OFF using **[▲]** or **[▼]**.
3. Save the setting by pressing and holding **[SCAN/MEM]**.

Key Beep

Key Beep is the tone sounded after a key press.

1. Press **[MENU/MON]** **15 times** to select **Key Beep**.
2. Scroll to select ON or OFF using **[▲]** or **[▼]**.
3. Save the setting by pressing and holding **[SCAN/MEM]**.

Battery Save

1. Press **[MENU/MON]** **16 times** to select **Battery Save**.
2. Scroll to select ON or OFF using **[▲]** or **[▼]**.
3. Save the setting by pressing and holding **[SCAN/MEM]**.

Smart Key [--]

Press and hold **[--]** to select and enter three Smart key functions.

NRC function

PRI function

CALL function

Short press **[--]** to active **NRC**, then select **NRC Level** from **[MENU]**.

Short press **[--]** to active **PRI**, PRI channel display, press again to off.

Short press **[--]** to send **CALL**, 30s waiting time between each **[CAL]**.

Operation | Menu Functions

Backlight (Timer)

The display backlight is set by default to AUTO mode which keeps the backlight ON for 15 seconds and then it turns off. It again gets enabled whenever there is a key press, or incoming signal.

To change the Backlight Timer time:

1. Press **[MENU/MON]** 14 times.
2. Press **[▲]** or **[▼]** to select ON/OFF or AUTO.
3. Save the setting by pressing and holding **[SCAN/MEM]**.



Changing the Backlight timer will affect the battery operating time (see *Battery Level Display*, page 10). For optimum battery operating time, avoid turning the backlight timer to ON (always on), and instead select a moderate duration.

Key Lock

To prevent accidental entries, you can lock the keypad. Only **[PTT]** and **[ON/OFF VOL]** are accessible when Key Lock is activated.

Press and hold **[-]**,  icon appears at the top right of the display when activated.

Repeat the process to disable key lock.

Factory Reset

If several settings have been changed and you want to reset the radio back to factory settings, follow these steps.

Reset all functions by press the **SMART KEY[--]** and **[PTT]** at the same time and then power on the radio. Default reset displays CH01 and the priority channel is CH05.

CTCSS Codes and Frequencies

Code No.	Frequency (Hz)	Code No.	Frequency (Hz)
"oF"	OFF	26	162.2
1	67.0	27	167.9
2	71.9	28	173.8
3	74.4	29	179.9
4	77.0	30	186.2
5	79.7	31	192.8
6	82.5	32	203.5
7	85.4	33	210.7
8	88.5	34	218.1
9	91.5	35	225.7
10	94.8	36	233.6
11	97.4	37	241.8
12	100.0	38	250.3
13	103.5		
14	107.2		
15	110.9		
16	114.8		
17	118.8		
18	123.0		
19	127.3		
20	131.8		
21	136.5		
22	141.3		
23	146.2		
24	151.4		
25	156.7		

DCS Codes and Frequencies

Code No.	DCS Code (Octal)	Code No.	DCS Code (Octal)	Code No.	DCS Code (Octal)
1	023	36	223	71	445
2	025	37	225	72	446
3	026	38	226	73	452
4	031	39	243	74	454
5	032	40	244	75	455
6	036	41	245	76	462
7	043	42	246	77	464
8	047	43	251	78	465
9	051	44	252	79	466
10	053	45	255	80	503
11	054	46	261	81	506
12	065	47	263	82	516
13	071	48	265	83	523
14	072	49	266	84	526
15	073	50	271	85	532
16	074	51	274	86	546
17	114	52	306	87	565
18	115	53	311	88	606
19	116	54	315	89	612
20	122	55	325	90	624
21	125	56	331	91	627
22	131	57	332	92	631
23	132	58	343	93	632
24	134	59	346	94	654
25	143	60	351	95	662
26	145	61	356	96	664
27	152	62	364	97	703
28	155	63	365	98	712
29	156	64	371	99	723
30	162	65	411	100	731
31	165	66	412	101	732
32	172	67	413	102	734
33	174	68	423	103	743
34	205	69	431	104	754
35	212	70	432		

UHF-CB Channel Guidelines



NOTE

Always listen on a channel (or observe the receive signal level meter) to ensure it is not already being used before transmitting.

Channels 5 and 35 are used for emergency channels.
CTCSS will not operate on these channels.

Please follow these guidelines for channel use in Australia:

- Channels 05 and 35 are Emergency Channels.
- Channel 11 is a Calling Channel.
- Channels 22 and 23 are for telemetry and telecommand applications and TX is inhibited on these channels.

General communication is accepted on all other channels with these guidelines:

- Channel 40 - road channel (Australia).
- Channels 01-08 (and 31-38), and Channels 41-48 (and 71-78) are repeater channels.

Important information - 80 Channel UHF-CB channel expansion

To provide all users additional channel capacity within the UHF-CB Band. The ACMA will change the majority of the current wideband 40 channel use to narrowband channel use. This allows for additional channels to be added, up to 80 Channels.

This simply means that the new narrowband radio you have purchased will have more channels than older radios. Please refer to the guidelines above and the channel chart for further channel information.

A list of currently authorised channels can also be obtained from the ACMA website in Australia and the MED website in New Zealand.



NOTE

Interference / Poor Audio

When a new narrowband radio receives a signal from an older wideband radio the speech may sound loud.

Narrowband radios operating on CH41 - CH80 may encounter interference from a nearby wideband radios transmitting on high power on an adjacent channel (frequency).

When an older wideband radio receives a signal from a new narrowband radio the speech may sound quiet - the wideband radio user simply adjusts their radio volume for best performance.

The above situations are not a fault of the radio but a symptom of mixed wideband and narrowband radios in current use. It is expected that as older wideband radios are phased out this issue will be eliminated.

UHF-CB Channels and Frequencies

CH No.	Simplex Mode Transmit / Receive Frequency (MHz)	Duplex Mode Transmit Frequency (MHz)	CH No.	Simplex Mode Transmit / Receive Frequency (MHz)
1	476.425	477.175 (CH31)	21	476.925
2	476.450	477.200 (CH32)	22	476.950 (RX only)
3	476.475	477.225 (CH33)	23	476.975 (RX only)
4	476.500	477.250 (CH34)	24	477.000
5	476.525	477.275 (CH35)	25	477.025
6	476.550	477.300 (CH36)	26	477.050
7	476.575	477.325 (CH37)	27	477.075
8	476.600	477.350 (CH38)	28	477.100
9	476.625		29	477.125
10	476.650		30	477.150
11	476.675		31	477.175
12	476.700		32	477.200
13	476.725		33	477.225
14	476.750		34	477.250
15	476.775		35	477.275
16	476.800		36	477.300
17	476.825		37	477.325
18	476.850		38	477.350
19	476.875		39	477.375
20	476.900		40	477.400

UHF-CB Channels and Frequencies

CH No.	Simplex Mode Transmit / Receive Frequency (MHz)	Duplex Mode Transmit Frequency (MHz)	CH No.	Simplex Mode Transmit / Receive Frequency (MHz)
41	476.4375	477.1875 (CH 71)	61	476.9375 (RX only)
42	476.4625	477.2125 (CH 72)	62	476.9625 (RX only)
43	476.4875	477.2375 (CH 73)	63	476.9875 (RX only)
44	476.5125	477.2625 (CH 74)	64	477.0125
45	476.5375	477.2875 (CH 75)	65	477.0375
46	476.5625	477.3125 (CH 76)	66	477.0625
47	476.5875	477.3375 (CH 77)	67	477.0875
48	476.6125	477.3625 (CH 78)	68	477.1125
49	476.6375		69	477.1375
50	476.6625		70	477.1625
51	476.6875		71	477.1875
52	476.7125		72	477.2125
53	476.7375		73	477.2375
54	476.7625		74	477.2625
55	476.7875		75	477.2875
56	476.8125		76	477.3125
57	476.8375		77	477.3375
58	476.8625		78	477.3625
59	476.8875		79	477.3875
60	476.9125		80	477.4125

Warranty

UNIDEN UH825 Series UHF CB Transceiver

IMPORTANT: Satisfactory evidence of the original purchase is required for warranty service

Please refer to our Uniden website for any details or warranty durations offered in addition to those contained below.

Warrantor: The warrantor is Uniden Australia Pty Limited ABN 58 001 865 498 ("Uniden").

Terms of Warranty: Uniden Aust warrants to the original retail purchaser only that the UH825 Series, or UH825-2TP Series ("the Product"), will be free from defects in materials and craftsmanship for the duration of the warranty period, subject to the limitations and exclusions set out below.

Warranty period: This warranty to the original retail purchaser is only valid in the original country of purchase for a Product first purchased either in Australia or New Zealand.

Product	3 Years
Battery Pack & Accessories	1 Year

If a warranty claim is made, this warranty will not apply if the Product is found by Uniden to be:

- (A) Damaged or not maintained in a reasonable manner or as recommended in the relevant Uniden Owner's Manual;
- (B) Modified, altered or used as part of any conversion kits, subassemblies or any configurations not sold by Uniden;
- (C) Improperly installed contrary to instructions contained in the relevant Owner's Manual
- (D) Repaired by someone other than an authorized Uniden Repair Agent in relation to a defect or malfunction covered by this warranty; or
- (E) Used in conjunction with any equipment, parts or a system not manufactured by Uniden.

Parts Covered: This warranty covers the Product and included accessories.

Warranty

User-generated Data: This warranty does not cover any claimed loss of or damage to user-generated data (including but without limitation phone numbers, addresses and images) that may be stored on your Product.

Statement of Remedy: If the Product is found not to conform to this warranty as stated above, the Warrantor, at its discretion, will either repair the defect or replace the Product without any charge for parts or service. This warranty does not include any reimbursement or payment of any consequential damages claimed to arise from a Product's failure to comply with the warranty.

Our goods come with guarantees that cannot be excluded under the Australian Consumer Law. You are entitled to a replacement or refund for a major failure and for compensation for any other reasonably foreseeable loss or damage. You are also entitled to have the goods repaired or replaced if the goods fail to be of acceptable quality and the failure does not amount to a major failure.

This warranty is in addition to and sits alongside your rights under either the COMPETITION AND CONSUMER ACT 2010 (Australia) or the CONSUMER GUARANTEES ACT (New Zealand) as the case may be, none of which can be excluded.

Procedure for obtaining warranty service: Depending on the country in which the Product was first purchased, if you believe that your Product does not conform with this warranty, you should deliver the Product, together with satisfactory evidence of your original purchase (such as a legible copy of the sales docket) to Uniden. Please refer to the Uniden website for address details. You should contact Uniden regarding any compensation that may be payable for your expenses incurred in making a warranty claim. Prior to delivery, we recommend that you make a backup copy of any phone numbers, images or other data stored on your Product, in case it is lost or damaged during warranty service.

UNIDEN AUSTRALIA PTY LTD

Phone: 1300 366 895

Email: custservice@uniden.com.au

THANK YOU FOR BUYING A UNIDEN PRODUCT.

Uniden[®]

© 2023 Uniden Australia Pty Limited. Printed in PRC.